

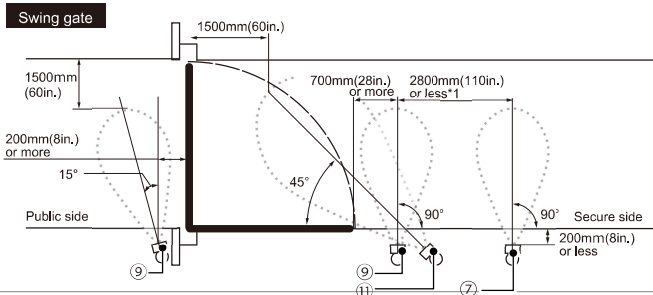

OVS-02GT Quick reference guide

1. Install the sensors with the layout shown below.

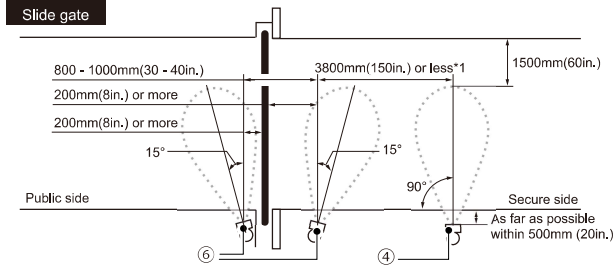
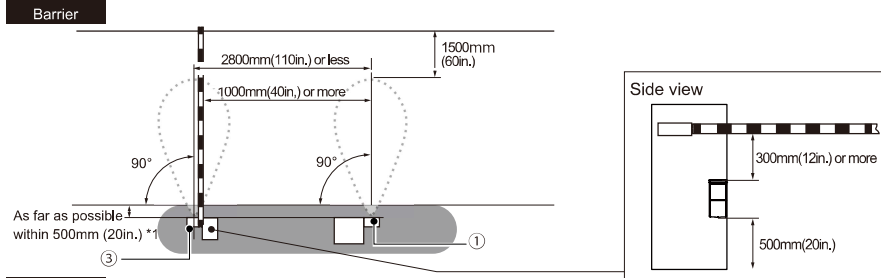

Application list

- ① Barrier - Activation 90deg
- ② Barrier - Activation 45deg(Free exit only)
- ③ Barrier - Protection 90deg
- ④ Slide gate - Activation 90deg
- ⑤ Slide gate - Activation 45deg
- ⑥ Slide gate - Protection 90deg
- ⑦ Swing gate - Activation 90deg
- ⑧ Swing gate - Activation 45deg
- ⑨ Swing gate - Protection 90deg
- ⑩ Swing gate - Shadow 90deg
- ⑪ Swing gate - Shadow 45deg

2. Installation and wiring

- [1] Drill holes to install the unit with pattern paper. [2] Run wires out from the pole before securing the sensor housing. Wiring holes are not required when using a conduit pipe.

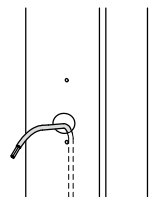
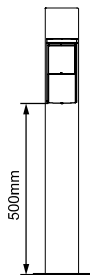

When using a conduit pipe

Break the knockout (wiring on conduit pipes)

Knockout diameter : $\Phi 21(27/32")$

Conduit pipe : 16

Screw : G1/2"

- [3] Loosen the screws on the top and bottom covers, and remove the covers. * Do not loosen the screws completely. The screws may fall out.

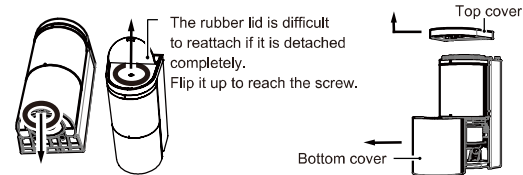

- [5] Fix the sensor housing with two screws.

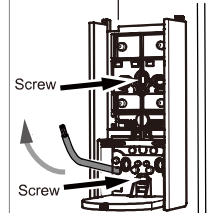

- [6] Cut the terminal cover with scissors and make a hole according to the wire diameter. (Select the smallest from among similar sizes.)

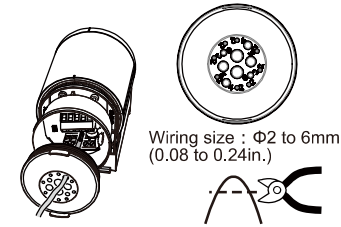

- [8] Install the sensor unit into the sensor housing. Rotate the sensor unit to adjust its angle (adjustable angle: 96° to left and right).

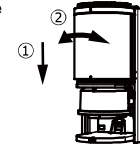

- 3. Set by smartphone App. Follow the procedure to set up and to perform calibration.

- After changing settings, be sure to tap the Send icon to send the settings to the sensor.

Calibration

Memorizes the background of the detection area when no pedestrians or vehicles are present. It makes the sensors performance higher and more stable.

Download the smartphone App form the 2D code or search it with words "OPTEX Virtual Loop" at AppStore or GooglePlay.

Q OPTEX VirtualLoop



- 4. For the operation check, use a vehicle to check the entire operation of the system.

- 5. Attach the top and bottom covers and Tighten the screws on the top and bottom covers..

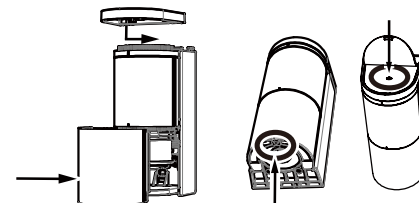

- [4] Detach the sensor unit by lifting it.

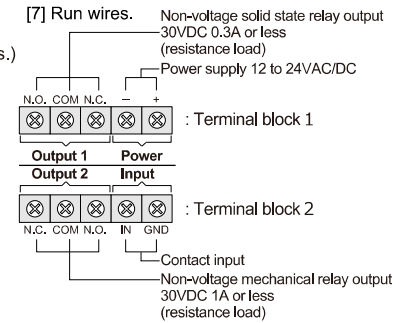
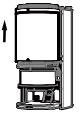

Pattern paper

